



# Premier LC Userguide

## Product Overview

Thank you for purchasing the Premier LC laser. This emits a visible/IR spot/projection. If you have any problems or require help when using the Premier LC please call us on +44 (0)1495 212213 or contact your local representative.

The Premier laser diode modules represent the highest level of optical and electrical performance at an economical price, a combination that is unmatched in the marketplace.

The secret of their superiority is a control circuit design that not only gives you excellent output power stability over time and temperature, but also offers fast, closed-loop modulation with an extinction ratio as high as 10,000:1. The LC version allows you to control the output intensity linearly by applying a voltage of between 0 to 1 volts, to the control input. The output intensity will faithfully replicate any arbitrary signal you wish to apply within the limits of the laser module's maximum rise and fall time. A wide range of wavelengths, powers and lens options are available, each combination having been carefully selected to provide you optimum performance, while ensuring the laser diode is never over driven.

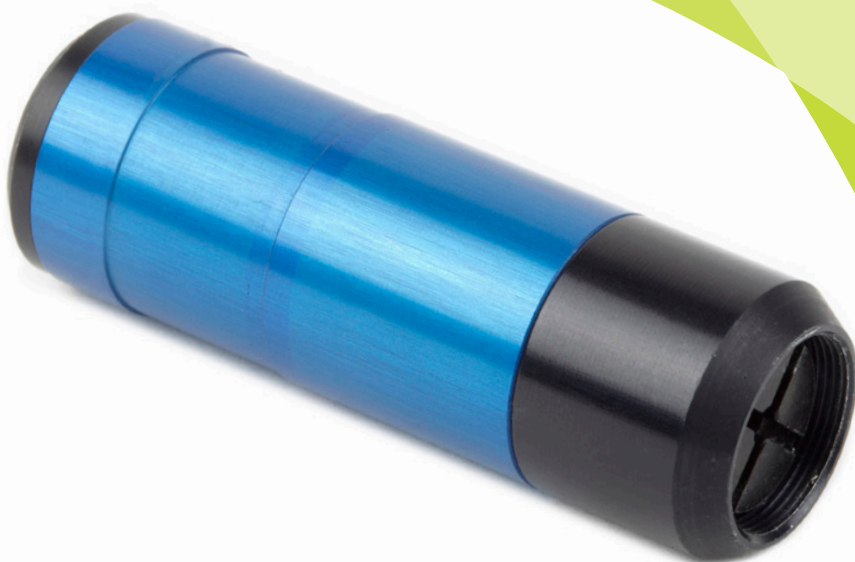

# Product Operation

## A: CW Mode

To operate the laser in CW mode connect 4 way JST (see diagram A) to back of laser module.

Pin	Lead	Red & IR Models	Green & Blue Models
Pin 1	Red Lead	+5 Vdc $\pm$ 250mV	+10 Vdc $\pm$ 250mV
Pin 2	Black Lead	0 Vdc	0 Vdc
Pin 3	Yellow Lead	Not Connected	Not Connected
Pin 4	Green/Yellow Lead	Earth	Earth

## B: Linear Modulation Function

To linearly modulate the laser any modulation signal up to 300kHz (dependant on diode) with an amplitude of 0V to +1Vdc can be applied to yellow lead.

Pin	Lead	Red & IR Models	Green & Blue Models
Pin 1	Red Lead	+5 Vdc $\pm$ 250mV	+10 Vdc $\pm$ 250mV
Pin 2	Black Lead	0 Vdc	0 Vdc
Pin 3	Yellow Lead	Input Modulation Signal 0 to +1 Vdc	Input Modulation Signal 0 to +1 Vdc
Pin 4	Green/Yellow Lead	Earth	Earth

## C. Setting the power via a resistor

Alternatively the yellow lead can be used for a linear power control function. In this situation, the laser power is denoted by a voltage applied to the yellow lead, 0V turning the laser off and +1Vdc giving maximum power, with linear trend between. (See linear intensity graph).

Pin	Lead	Red & IR Models	Green & Blue Models
Pin 1	Red Lead	+5 Vdc $\pm$ 250mV	+10 Vdc $\pm$ 250mV
Pin 2	Black Lead	0 Vdc	0 Vdc
Pin 3	Yellow Lead	Input Modulation Signal 0 to +1 Vdc	Input Modulation Signal 0 to +1 Vdc
Pin 4	Green/Yellow Lead	Earth	Earth

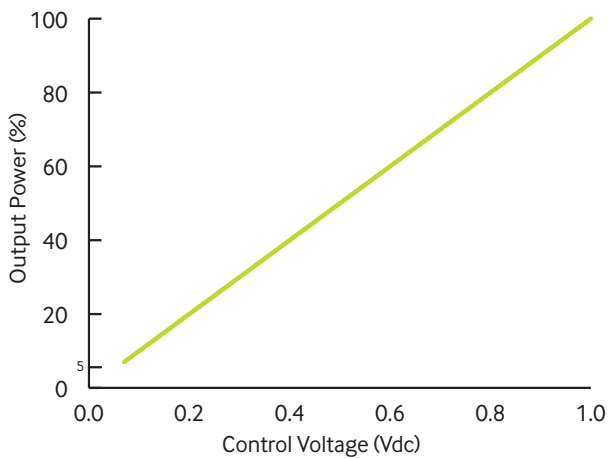

#### D) Setting the Output Power Via a Resistor

The control wire has a 10k Ohm input impedance connected to an internal 1V source which is used as the reference for the factory set power. Measuring the voltage between the Yellow and Black wires with a high (>10M Ohm) impedance voltmeter, will give a reading of 1 V ± 2%. Connecting a 10k Ohm resistance between the Yellow and Black wires will result in the reading falling to 0.5V and the light output falling to half the factory set power. Other outputs between 0 and the factory set

power can be achieved with a single resistor Rx by using the formula:

Where  $P_o$  is the required power output  
as  $P_{fs}$  is the factory set power

$$R_X = \frac{P_o * 10K}{P_{fs} - P_o}$$

#### Green/Yellow Lead (Case earth)

The Green/Yellow is internally connected to 0 volts via a 1MΩ resistor to provide a resistive dissipation path for EMC & Static protection. If your power supply has a mains ground connection connect the Green/Yellow wire to it, otherwise connect it to 0V along with the Black wire.

## Focus Adjustment

The focus of the of the Premier can by using the supplied focus key. Should you need to adjust the focus please follow these simple instructions.

#### Premier fitted with dot optics

1. Insert focus key into laser barrel and align with focus control groves.
2. Turn the focus key until desired focus is achieved.

#### Premier fitted with projection optics

1. Remove any external optics, where fitted (see drawing B).
2. Insert focus key into laser barrel and align with focus control groves.
3. Turn the focus key until desired focus is achieved.
4. Replace the external optics if fitted and rotate to achieve the desired projection.

# Mounting

The lifetime and stability of your laser can be optimised when mounted on a suitable heat sink. This allows the case temperature to be kept within its specified range. Failure to properly heat sink your laser device could result in shortened lifetime or failure of the diode. As a general guideline, the lifetime of a laser diode decreases by a factor of two (approx.) for every 10°C increase in operating temperature.

There are three mounting clamps available for the Premier: heavy duty clamp (with/without magnetic, swivel clamp and pillow block bearing mount.

## **Mounting the Premier in the Heavy Duty Clamp (See drawing C)**

1. Secure the clamp to a surface. There are two methods:
  - a. Screw an M5 stud to the bottom of the base, or
  - b. Remove the base by removing 2 x grub screw B with the supplied Allen key, then thread an M5 cap screw through the top of the base. Then re-attach the base to the body of the clamp.
2. Loosen Allen screw A with the supplied Allen key
3. Slide your laser into the mounting hole and then tighten Allen screw A
4. Loosen grub screw A
5. Adjust the vertical angle of your laser and then tighten grub screw A
6. Loosen 2 x grub screw B. This will allow the main body of the mount to be rotated independently of the base
7. Adjust the horizontal angle of your laser and then tighten 2 x grub screw B

## **Mounting the Premier in the Heavy Duty Clamp with Magnetic Base (See drawing C & D)**

1. Secure the magnetic base to the Heavy Duty Clamp
  - a. Screw the stud on the top of the magnetic base into the centre hole at the bottom of the Heavy Duty Clamp
2. Remove the keeper from the magnetic base and place on a ferrous surface
3. Loosen Allen screw A with the supplied Allen key
4. Slide your laser into the mounting hole and then tighten Allen screw A
5. Loosen grub screw A
6. Adjust the vertical angle of your laser and then tighten grub screw A
7. Loosen 2 x grub screw B. This will allow the main body of the mount to be rotated independently of the base
8. Adjust the horizontal angle of your laser and then tighten 2 x grub screw B

## **Mounting the Premier in the Swivel Mounting Clamp (See drawing E)**

1. Secure the mounting base to a surface
  - a. You can use 2 x Ø9 mm slots, 4 x Ø4.5 mm holes, and/or 2 x Ø3.5 mm countersunk holes to achieve this. If mounting via Ø3.5mm countersunk holes, the swivel bracket must be removed from the base and then reattached after mounting.
2. Loosen Allen screw A (M3)

3. Slide your laser into the mounting hole and then tighten Allen screw A
4. Loosen Allen screw B (M5)
5. Adjust tilt angle and then tighten Allen screw B
6. Loosen 2 x M4 screws attaching swivel bracket to base
7. Adjust swivel angle and then tighten 2 x M4 screws remains with the user.

### Mounting the Premier in the Pillow Block Bearing Mount (See Drawing F)

1. Secure the mount to your workbench or surface using the 20 x 11 mm oval slots in the base
2. Unscrew the M6 or M8 socket head screws to remove the clamp from the base
3. Separate the black mounting cylinder from the spherical rolling element
4. Insert your laser into the mounting cylinder
5. Replace both halves of the spherical rolling element around the cylinder and hold in place
6. Position the spherical rolling element and mounting cylinder in the curved section of the clamp and hold in place
7. Replace the other half of the clamp and hold in place
8. Screw the M6 or M8 socket head screws through the clamp and into the base
9. Manually adjust the direction of your laser

## Cleaning The Optics

If the laser pattern becomes fuzzy or unclear, please check the following:

1. Check the laser is in focus.
2. Remove contaminants with a compressed air duster.
3. Contact Global Laser or your local representative if you still have issues.

**Note:** Handle optics with care using powder-free latex or nitrile gloves. These prevent the transfer of oils and debris from hands to optics.

## Safety & Classification

These modules are intended for incorporation into customer equipment. They are classified in accordance with IEC60825-1 2014, which should be consulted prior to designing or using any laser product. The following labels are supplied for attachment to the customer’s equipment, but responsibility for compliance with the standard remains with the user.

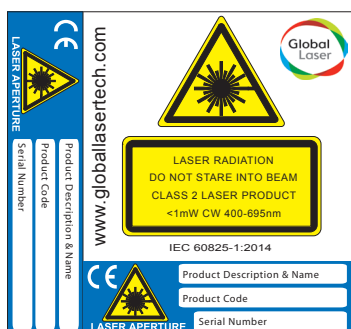

Class 2 Laser Label

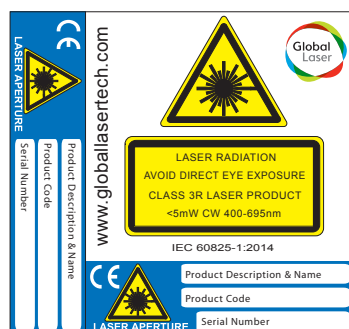

Class 3R Laser Label

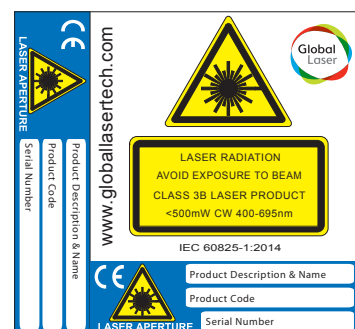

Class 3B Laser Label

# Diagrams

## A) Premier LC

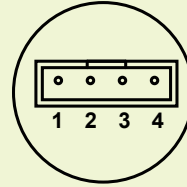
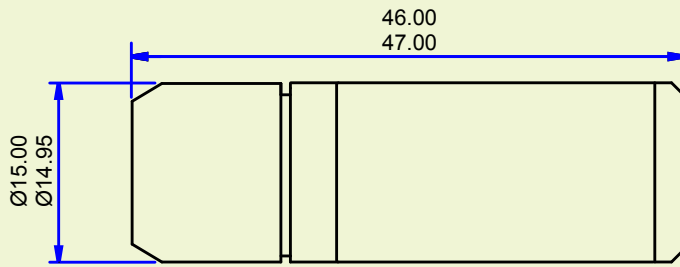

Pin 1 - Red  
Pin 2 - Black  
Pin 3 - Yellow  
Pin 4 - Green/Yellow

## B) Premier LC with External Optic

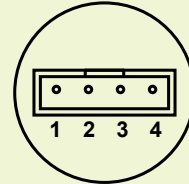
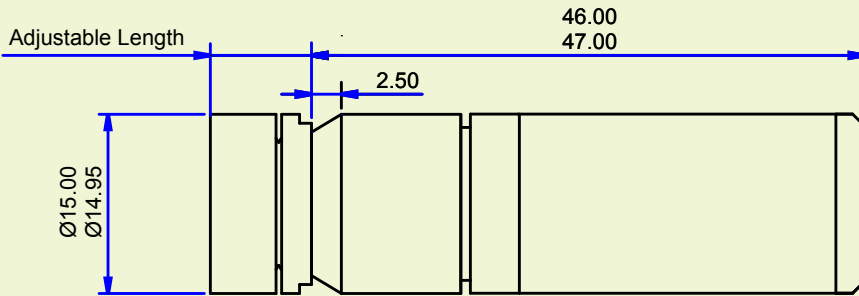

Pin 1 - Red  
Pin 2 - Black  
Pin 3 - Yellow  
Pin 4 - Green/Yellow

## C) Heavy Duty Mounting Clamp

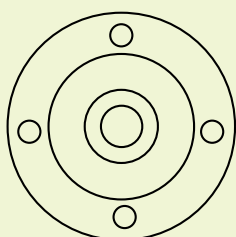
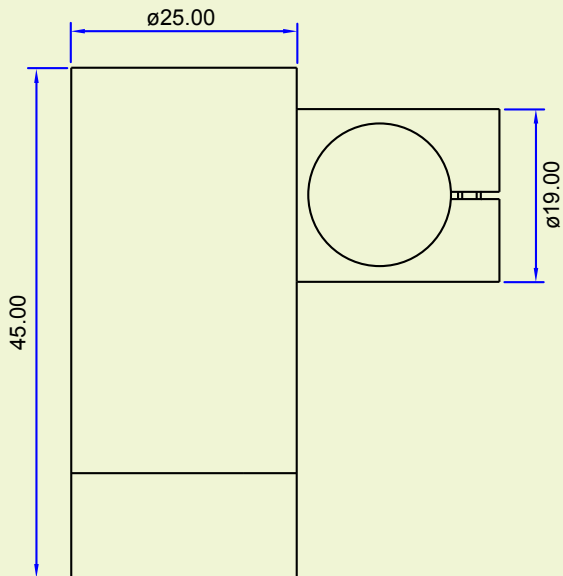

M5 Mounting hole on base

## D) Magnetic Base

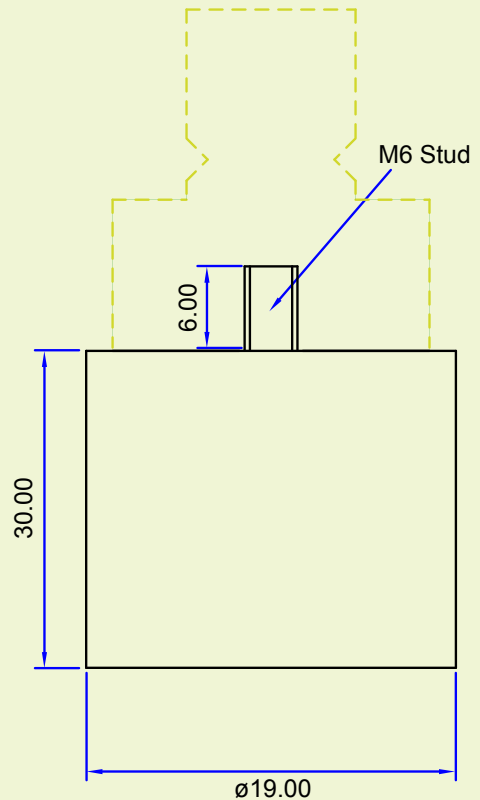

### E) Swivel Mounting Clamp

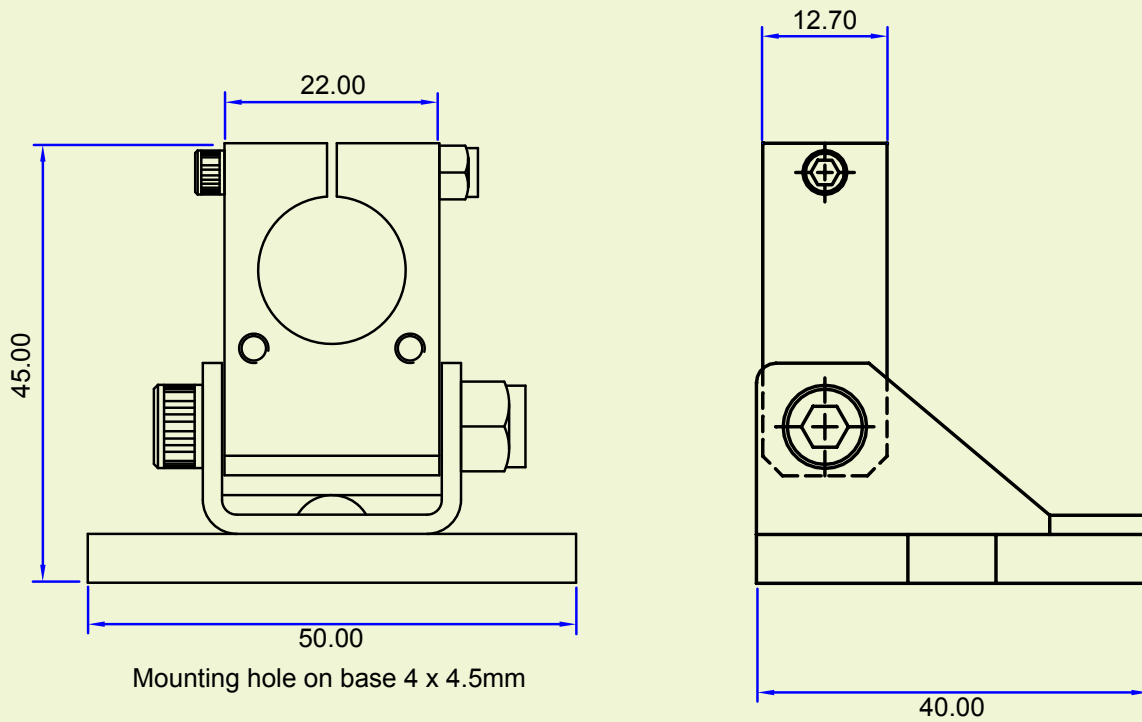

### F) Pillow Block Bearing Clamp

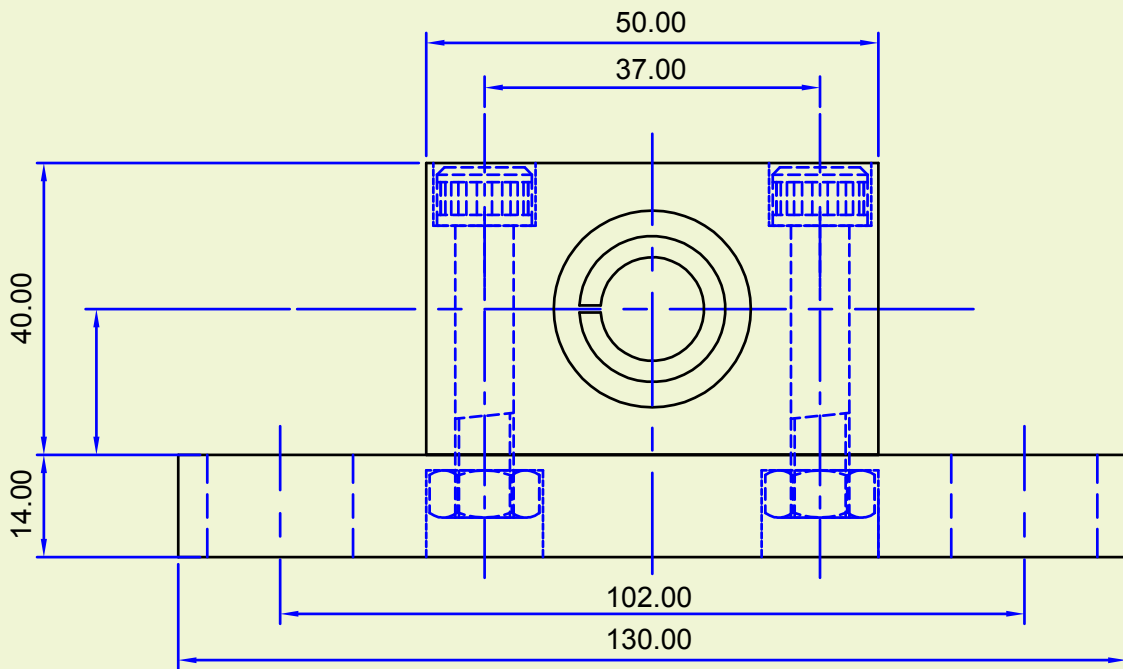

Please Note: Global Laser reserve the right to change descriptions and specifications without notice.



T: +44 (0)1495 212213  
F: +44 (0)1495 214004  
E: sales@globallasertech.com  
www.globallasertech.com

Global Laser Ltd  
Unit 9-10  
Roseheyworth Business Park  
Abertillery, Gwent NP13 1LZ UK