

FOCAL LENGTH (EFL): 100 ± 1
 BACK FOCAL LENGTH (BFL): $97,92$

SURFACE A	SURFACE B	SURFACE C
$\phi_e 11,5$	$\phi_e 11,5$	$\phi_e 11,5$
CEMENT: NOA 61 OR EQUIVALENT		

PROTECTIVE CHAMFERS AS NEEDED		FIRST ANGLE PROJECTION			
ROHS: COMPLIANT	SCALE: NONE $\lambda = 587,6\text{nm}$				
SPECIFICATIONS SUBJECT TO CHANGE WITHOUT NOTICE. DIMENSIONS ARE FOR REFERENCE ONLY			TITLE	12,5mm Dia, x 100mm FL, VIS 0 Coated, Achromatic Lens	
FOR INFORMATION ONLY: DO NOT MANUFACTURE PARTS TO THIS DRAWING			ALL DIMS IN: mm	DWG NO	47672
INDICATIONS IN ACCORDANCE WITH ISO 10110					SHEET 1 OF 3

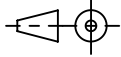
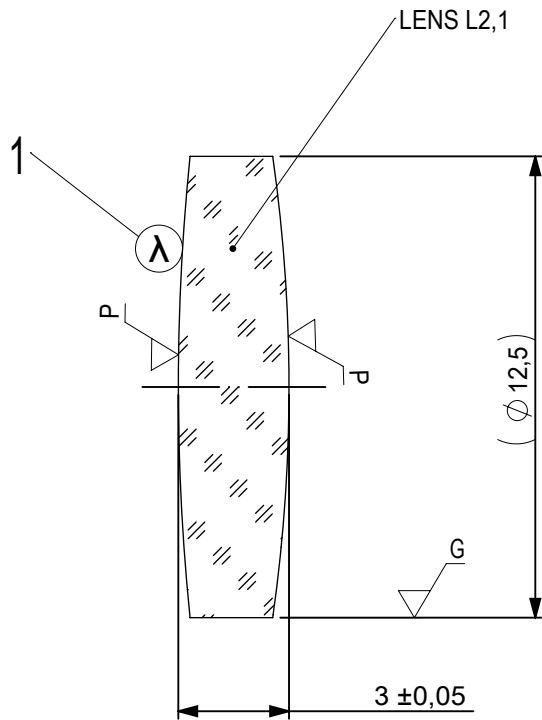

1 AR COATING: VIS 0°
R(AVG) ≤ 0,4% FROM 425-675nm @ 0° AOI

LEFT SURFACE	MATERIAL	RIGHT SURFACE
R 61,54±0,062 CX Øe 11,5 3/ 3 (0,5) λ=632,8 nm 4/ - 5/ 40 - 20 (MIL-PRF-13830B) 6/ -	GLASS N-BK7 517/642	R 44,39±0,044 CX Øe 11,5 3/ 3 (0,5) λ=632,8 nm 4/ - 5/ 40 - 20 (MIL-PRF-13830B) 6/ -

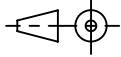
PROTECTIVE CHAMFERS AS NEEDED		FIRST ANGLE PROJECTION	 Edmund Optics®			
ROHS: COMPLIANT	SCALE: NONE λ = 587,6nm					
SPECIFICATIONS SUBJECT TO CHANGE WITHOUT NOTICE. DIMENSIONS ARE FOR REFERENCE ONLY			TITLE	12,5mm Dia, x 100mm FL, VIS 0 Coated, Achromatic Lens		
FOR INFORMATION ONLY: DO NOT MANUFACTURE PARTS TO THIS DRAWING			ALL DIMS IN:	mm	DWG NO	
INDICATIONS IN ACCORDANCE WITH ISO 10110				47672	SHEET SIZE A4	SHEET 2 OF 3

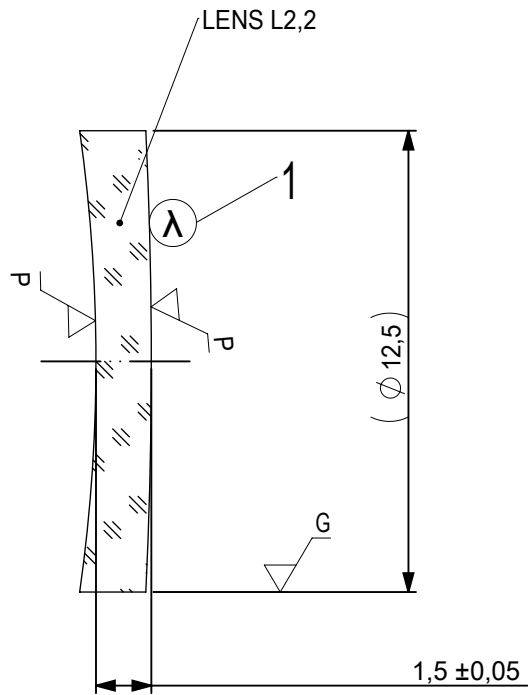

1 AR COATING: VIS 0°
R(AVG) ≤ 0,4% FROM 425-675nm @ 0° AOI

LEFT SURFACE	MATERIAL	RIGHT SURFACE
R 44,39±0,044 CV Øe 11,5 3/ 3 (0,5) λ=632,8 nm 4/ - 5/ 40 - 20 (MIL-PRF-13830B) 6/ -	GLASS N-SF5 673/322	R 130,26±0,13 CX Øe 11,5 3/ 3 (0,5) λ=632,8 nm 4/ - 5/ 40 - 20 (MIL-PRF-13830B) 6/ -

PROTECTIVE CHAMFERS AS NEEDED

ROHS: COMPLIANT
SCALE: NONE λ = 587,6nm

SPECIFICATIONS SUBJECT TO CHANGE WITHOUT NOTICE. DIMENSIONS ARE FOR REFERENCE ONLY

FOR INFORMATION ONLY: DO NOT MANUFACTURE PARTS TO THIS DRAWING

INDICATIONS IN ACCORDANCE WITH ISO 10110

FIRST ANGLE PROJECTION

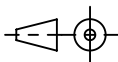

ALL DIMS IN: mm



Edmund Optics®

TITLE

12,5mm Dia, x 100mm FL, VIS 0 Coated, Achromatic Lens

DWG NO

47672

SHEET SIZE
A4

SHEET
3 OF 3