

Pixelink®

A NANITAR COMPANY









PL-D7715

CMOS | ON SEMI MT9F002 | ROLLING SHUTTER

The PL-D family of cameras links together the benefits of high frame rate CMOS technology with the high speed data throughput of USB 3.0 technology. The PL-D7715 camera provides low noise images for outstanding value for a broad range of industrial applications.



KEY FEATURES

 <p>15MP CMOS</p>	 <p>13 FRAMES Per Sec.</p>	 <p>1.4µm</p>	 <p>7.93mm</p>	 <p>Sensor Size 1/2.2"</p>
 <p>12 BIT</p>	 <p>COLOR</p>	 <p>USB 3</p>	 <p>USB VISION</p>	

TYPICAL APPLICATIONS

Parts inspection
Strength Testing
Metrology

Biometrics
Medical Imaging
PCB & Flat Panel Display Inspection

TECHNICAL SPECIFICATIONS

SENSOR

Sensor	ON Semi MT9F002
Type	CMOS Rolling Shutter
Resolution	15 MP (4608 x 3288)
Pixel Pitch	1.4 μm x 1.4μm
Active Area	7.93 mm diagonal
Peak QE	57% @ 535nm

PERFORMANCE SPECIFICATIONS

FPN	< 1% of signal
PRNU	< 2% of signal
Dynamic Range	60.5 dB
Bit Depth	8 & 12-bit
Color Data Formats	Bayer 8, Bayer 12 Packed, Bayer 16 & YUV422

FRAME RATES

Resolution	Free Running
4608 x 3288	13 fps
1280 x 1024	118.1 fps
1024 x 768	180 fps

Frame rates will vary based on host system and configuration

INTERFACES

Interface Data rate	USB 3.0 Micro-B 5Gbps
Board Level Trigger Connector	8-pin Molex 1.25mm pitch
Enclosed Trigger Connector	Hirose round 8-pin
Trigger	Software and hardware
Board Level Trigger Input	1 input, 3.3V (with internal pullup resistor)
Enclosed Trigger Input	1 optically Isolated, 5-12V DC at 4-11 mA
Board Level GPO/Strobe	2 outputs, 3.3V
Enclosed GPO/Strobe	2 outputs, 3.3V and 1 optically isolated max 40V DC, max 15mA
GPI	1 input, 3.3V (with internal pullup resistor)

MECHANICALS

Dimensions (mm)	55 x 38.5 x 30.0
Weight (g)	35.8 (Board level without optics)
Mounting	C-Mount and S-Mount

POWER REQUIREMENTS

Voltage Required	5V DC (from USB connector)
------------------	----------------------------

PIN NAME & FUNCTION

1	3.3V power output
2	TRIGGER/GPI 3.3V HCMOS input
3	Ground
4	GPO1, 3.3V HCMOS output
5	GPO2, 3.3V HCMOS output
6	Clock, 3.3V (I2C access for OEMs)
7	Data, 3.3V (I2C access for OEMs)
8	No connection

Board connector: Molex (8-pin, 1.25mm pitch, vertical); Cable receptacle: Molex 51021-0800; Cable crimp terminals: Molex 50079-8100

ENCLOSED GPIO INTERFACE PIN OUTPUT DESCRIPTION

1	VBUS (Power output from USB3 cable)
2	TRIGGER + (optically isolated)
3	TRIGGER - (optically isolated)
4	GPO1 + (optically isolated)
5	GPO1 - (optically isolated)
6	GPO1, 3.3V HCMOS output (I2C - SCL for autofocus)
7	GPO2, 3.3V HCMOS output (I2C - SDA for autofocus)
8	Ground (logic and chassis ground)

ENVIRONMENTAL & REGULATORY

Compliance	FCC, CE & RoHS
Shock & Vibration	300 G & 20 G (10Hz - 2KHz)
Operating Temperature	0°C to 50°C
Storage Temperature	-45°C to 85°C

SOFTWARE

Pixelink Capture	Control & operate multi-camera
Pixelink SDK	Software Development Kit
Pixelink μScope	Acquisition, analysis & reporting
3rd. Party U3V Vision Applications	

COMPUTER & OPERATING SYSTEM

	Windows	Linux x86	Linux ArmV7	Linux ArmV8
Processor	Intel i5 or better	Intel i5 or better	Arm7 (32 bit)	Arm8 (64 bit)
Memory	4GB recommended	4GB recommended	2GB	2GB
Hard Drive Space	150 MB	150 MB	50 MB	50 MB
Operating System	Windows 7/8/10	Ubuntu 14.04/16.04 Desktop	Ubuntu 14.04/16.04	Ubuntu 14.04/16.04

MECHANICAL DRAWINGS & RESPONSIVITY CURVES

MECHANICAL DRAWINGS

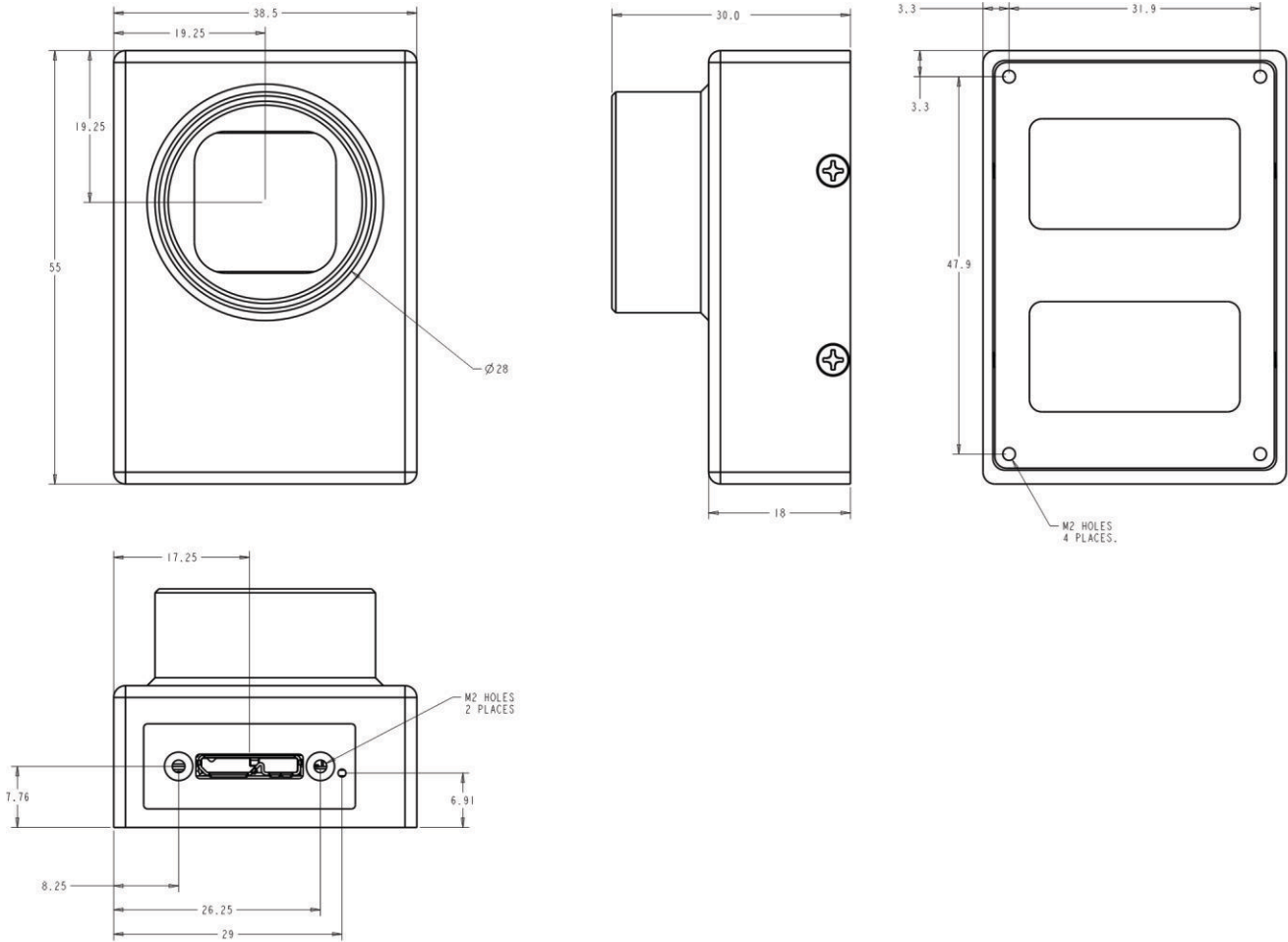

RESPONSIVITY CURVE - COLOR

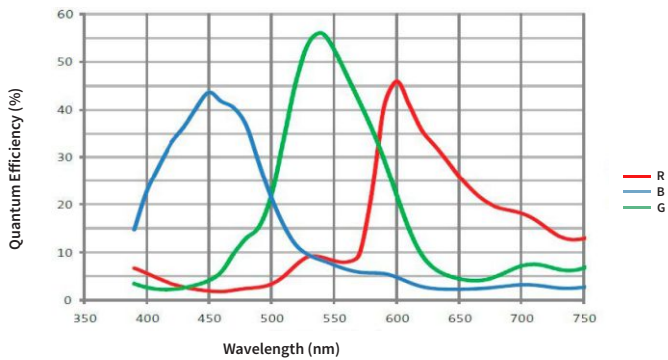

PIXELINK'S INDUSTRY LEADING SOFTWARE

PIXELINK CAPTURE

Pixelink Capture is powerful multi-camera software application designed to configure "n" numbers of cameras and stream "n" number of cameras simultaneously in real-time high-quality video viewed in a multi-window environment. Pixelink Capture offers options for complex image enhancements such as; exposure control, filtering, frame-by-frame property changes in addition to multi-camera application testing and configuration.

Pixelink Capture also provides features to measure supporting; point, line, circle, rectangle, polyline and polygon measurements while determining pixel location. After creating spatial calibration, the user can then review and adjust before exporting the findings to an Excel spreadsheet for further analysis. Pixelink Capture also has integrated lens control (zoom & focus) for Navitar motorized lenses and accurate autofocus options for Navitar motorized fine focus mechanisms.

Visit pixelink.com for more detailed information.

PIXELINK SDK

Providing full control of all camera functions, the **Pixelink Software Developers Kit (SDK)** is the software package of choice for developers and system integrators who are integrating Pixelink cameras into their applications. The Pixelink SDK provides access to the full Pixelink Application Programming Interface (API) and provides sample applications, wrappers for many 3rd party controls, such as LabVIEW, along with full documentation.

The Pixelink SDK is compatible with Microsoft Windows and popular Linux platforms. When using the Pixelink SDK, developers can integrate Pixelink cameras into their custom applications with ease.

Visit pixelink.com for more detailed information.

AVAILABLE CONFIGURATIONS

PL-D7715CU
PL-D7715CU-BL
PL-D7715CU-T

PL-D7715CU-S-BL
PL-D7715CU-CS-BL
PL-D7715CU-AF16

PL-D7715CU-AF25
PL-D7715CU-BL-AF16
PL-D7715CU-BL-AF25

PL-D7715CU-S-BL-AF2.6
PL-D7715CU-S-BL-AF7.5
PL-D7715CU-S-BL-AF9.6

Color Space

C = Color
M = Mono
NIR = Near Infrared

Interface

F = Firewire
G = GigE
U = USB

Housing

CS = CS Mount
S-BL = S Mount Board Level
BL = Board Level
T = Trigger

Autofocus

AF = Autofocus Lens (in mm)