

NOTES:

- 1. MATERIAL: STAINLESS STEEL
- 2. RoHS: COMPLIANT

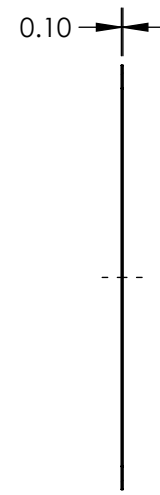
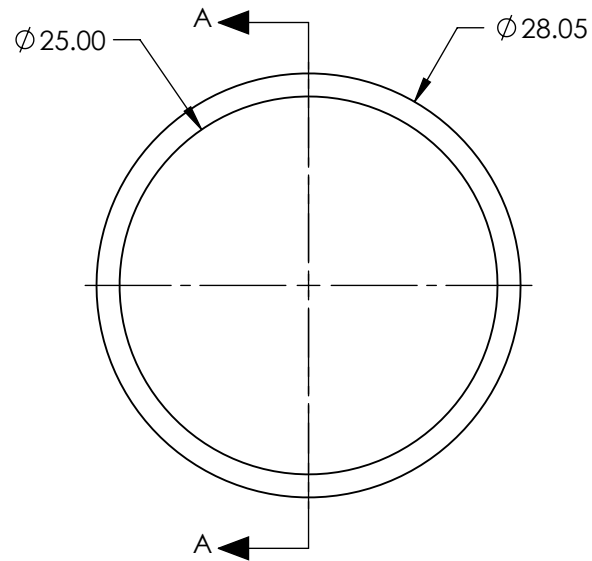
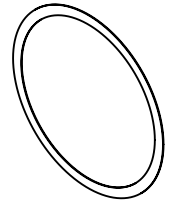

SECTION A-A

SPECIFICATIONS SUBJECT TO CHANGE WITHOUT NOTICE
DIMENSIONS ARE FOR REFERENCE ONLY

**FOR INFORMATION ONLY:
DO NOT MANUFACTURE
PARTS TO THIS DRAWING**

EO[®] **Edmund Optics**[®]

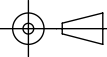
THIRD ANGLE PROJECTION 		TITLE	T32 INNER SPACER RING 0.10mm	
ALL DIMS IN	mm	DWG NO	11188	SHEET 1 OF 1