

NOTES:

1. SUBSTRATE: UV FUSED SILICA
2. SURFACE S2 TO BE PARALLEL WITH SURFACE S1 TO WITHIN 5 arcsec
3. COATING (APPLY ACROSS COATING APERTURE)

S1: HARD DIELECTRIC SPUTTERED
 T(avg): >91% FROM 333 - 1600nm @ 0° AOI
 T(avg): ≤0.01% FROM 200 - 315nm @ 0° AOI
 T(abs): =50% FOR 325±3.25nm @ 0° AOI

S2: SINGLE LAYER MgF2

4. FINE GRIND SURFACE

5. POWER, IRREGULARITY, AND SURFACE QUALITY SPECIFICATIONS APPLY ACROSS CLEAR APERTURE
6. TRANSMITTED WAVEFRONT DISTORTION, RMS: ≤λ/4 @ 633nm (prior to coating)
7. ROHS COMPLIANT

**FOR INFORMATION ONLY:
 DO NOT MANUFACTURE
 PARTS TO THIS DRAWING**

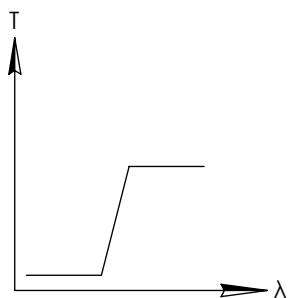
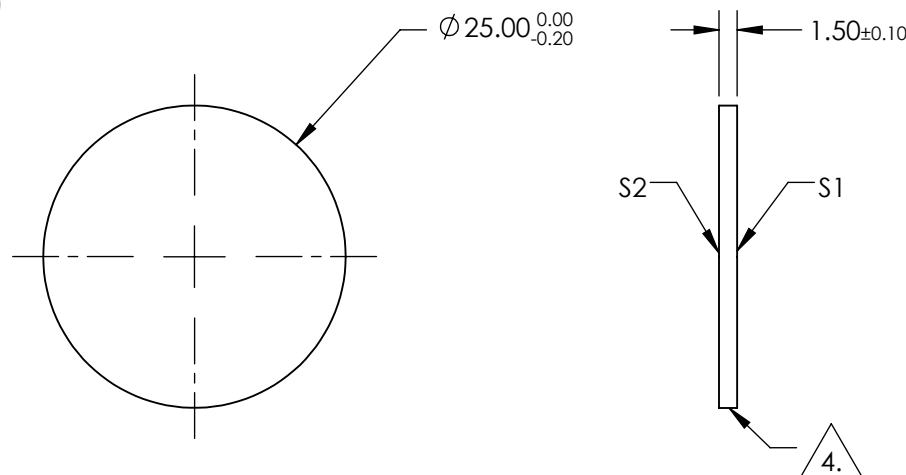
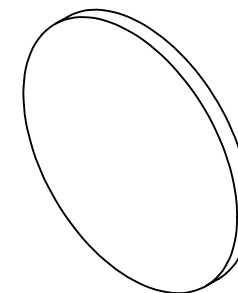

LONGPASS FILTER

SPECIFICATIONS SUBJECT TO CHANGE WITHOUT NOTICE
 DIMENSIONS ARE FOR REFERENCE ONLY

	S1	S2
SHAPE	PLANO	PLANO
SURFACE QUALITY	60-40	60-40
CLEAR APERTURE	>80%	>80%
BEVEL	PROTECTIVE AS NEEDED	PROTECTIVE AS NEEDED

EO® Edmund Optics®

THIRD ANGLE PROJECTION

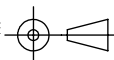

TITLE

Ø25mm, 325nm, HIGH PERFORMANCE
 LONGPASS FILTER

ALL DIMS IN

mm

DWG NO

34296

SHEET
 1 OF 1