

NOTES:

1. SUBSTRATE:
GRADE A FINE ANNEALED
SCHOTT: N-LaSF9 850/322
2. ROHS COMPLIANT
3. CENTERING TOLERANCE (AT 587.6nm):
BEAM DEVIATION (HALF ANGLE): <45 ARCMIN
4. COATING (APPLY ACROSS COATING APERTURE)

S1: NONE
S2: NONE

5. FINE GRIND SURFACE

6. POWER, IRREGULARITY, AND SURFACE QUALITY SPECIFICATIONS APPLY ACROSS CLEAR APERTURE
7. FOCAL LENGTH (EFL): 2.00mm ±1%
BACK FOCAL LENGTH (BFL): 1.57mm
8. PROTECTIVE BEVEL AS NEEDED
9. DESIGN WAVELENGTH: 587.6nm

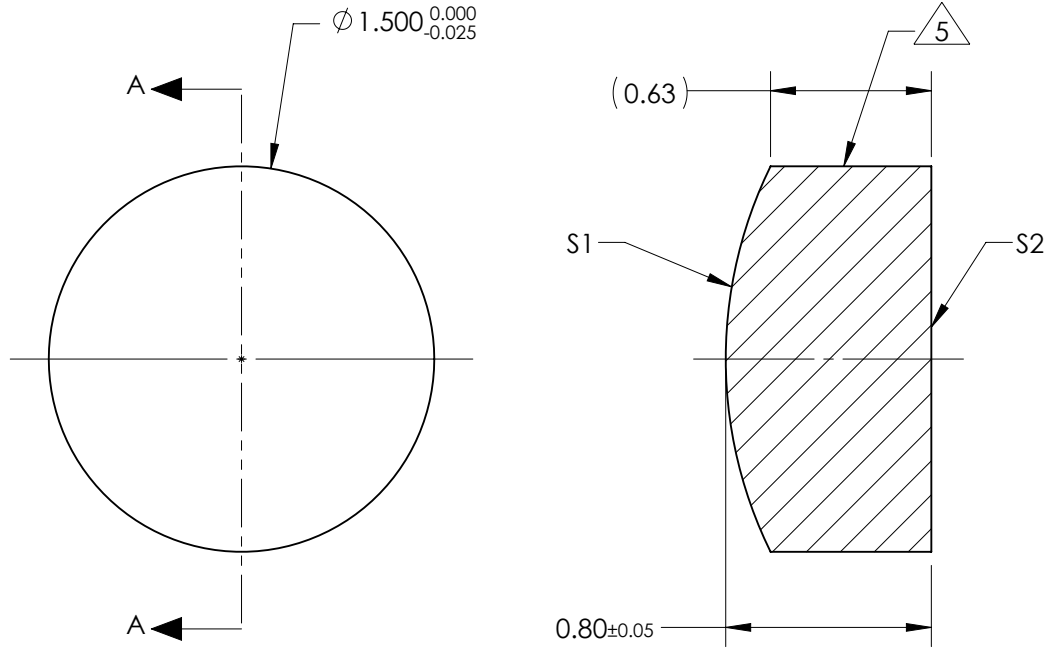

SECTION A-A

***FOR INFORMATION ONLY:
DO NOT MANUFACTURE
PARTS TO THIS DRAWING***

	S1	S2
SHAPE	CONVEX	PLANO
RADIUS	1.70	INFINITY
SURFACE QUALITY	20 - 10	20 - 10
MIN CLEAR APERTURE	$\phi 1.00$	$\phi 1.00$
MIN COATING APERTURE	N/A	N/A
POWER AT 632.8nm	3.00 RINGS	3.00 RINGS
IRREGULARITY AT 632.8nm	0.50 RINGS	0.50 RINGS

SPECIFICATIONS SUBJECT TO CHANGE WITHOUT NOTICE
DIMENSIONS ARE FOR REFERENCE ONLY

EO® Edmund Optics®

THIRD ANGLE PROJECTION		TITLE	1.5mm Dia. x 2.0mm FL, Uncoated, Plano-Convex Lens
ALL DIMS IN	mm	DWG NO	65254
			SHEET 1 OF 1