

NOTES:

1. SUBSTRATE:
ELEMENT A: N-BAF10 670/472
ELEMENT B: N-SF57 847/238
2. ROHS COMPLIANT
3. CENTERING TOLERANCE (AT 587.6nm):
BEAM DEVIATION (HALF ANGLE): <1 ARCMIN
4. COATING (APPLY ACROSS COATING APERTURE)

S1 & S4: VIS-NIR
R(ABS) ≤ 0.25% @ 880nm @ 0° AOI
R(AVG) ≤ 1.25% FROM 400 - 870nm @ 0° AOI
R(AVG) ≤ 1.25% FROM 890 - 1000nm @ 0° AOI

S2 & S3: NONE

- 5 FINE GRIND SURFACE
- 6. POWER, IRREGULARITY, AND SURFACE QUALITY SPECIFICATIONS APPLY ACROSS CLEAR APERTURE
- 7. FOCAL LENGTH (EFL): 12.00mm±1%
BACK FOCAL LENGTH (BFL): 8.33mm
- 8. PROTECTIVE BEVEL AS NEEDED
- 9. DESIGN WAVELENGTH: 587.6nm
- 9 ELEMENTS TO BE CEMENTED WITH NORLAND OPTICAL ADHESIVE NOA61

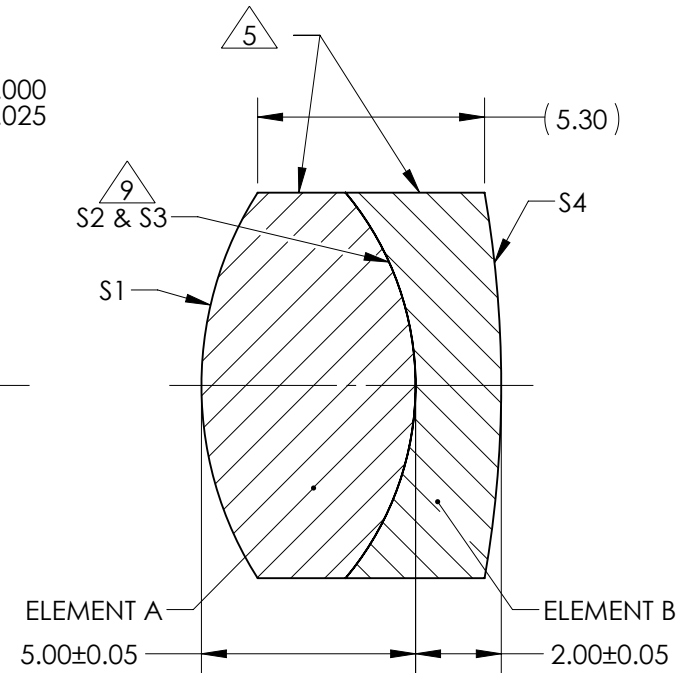
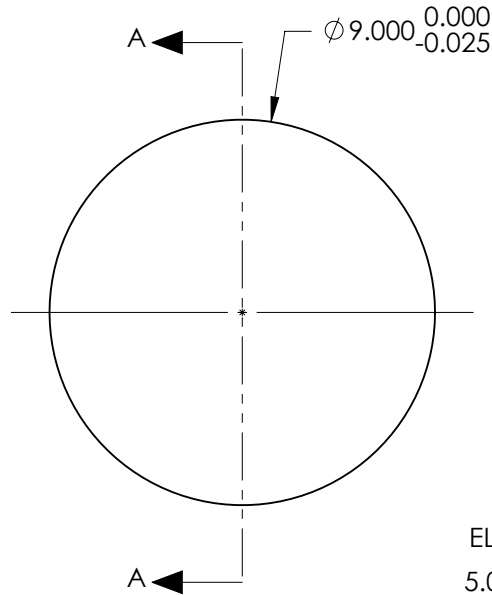

SECTION A-A

**FOR INFORMATION ONLY:
DO NOT MANUFACTURE
PARTS TO THIS DRAWING**

ELEMENT TITLE	SPECIFICATIONS AFTER CEMENTING			
	ELEMENT A		ELEMENT B	
SURFACE	S1	S2	S3	S4
SHAPE	CONVEX	CONVEX	CONCAVE	CONVEX
RADIUS	8.37	7.01	7.01	26.18
SURFACE QUALITY	40 - 20	40 - 20	40 - 20	40 - 20
MIN CLEAR APERTURE	Ø8.10	Ø8.10	Ø8.10	Ø8.10
MIN COATING APERTURE	Ø8.00	N/A	N/A	Ø8.00
POWER AT 632.8nm	3.00 RINGS	3.00 RINGS	3.00 RINGS	3.00 RINGS
IRREGULARITY AT 632.8nm	0.50 RINGS	0.50 RINGS	0.50 RINGS	0.50 RINGS

SPECIFICATIONS SUBJECT TO CHANGE WITHOUT NOTICE
DIMENSIONS ARE FOR REFERENCE ONLY

EO® Edmund Optics®

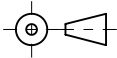
THIRD ANGLE PROJECTION 

ALL DIMS IN mm

TITLE	9mm Dia. x 12mm FL, VIS-NIR Coated, Achromatic Lens	
DWG NO	49313	SHEET 1 OF 1